

7.87in Reference

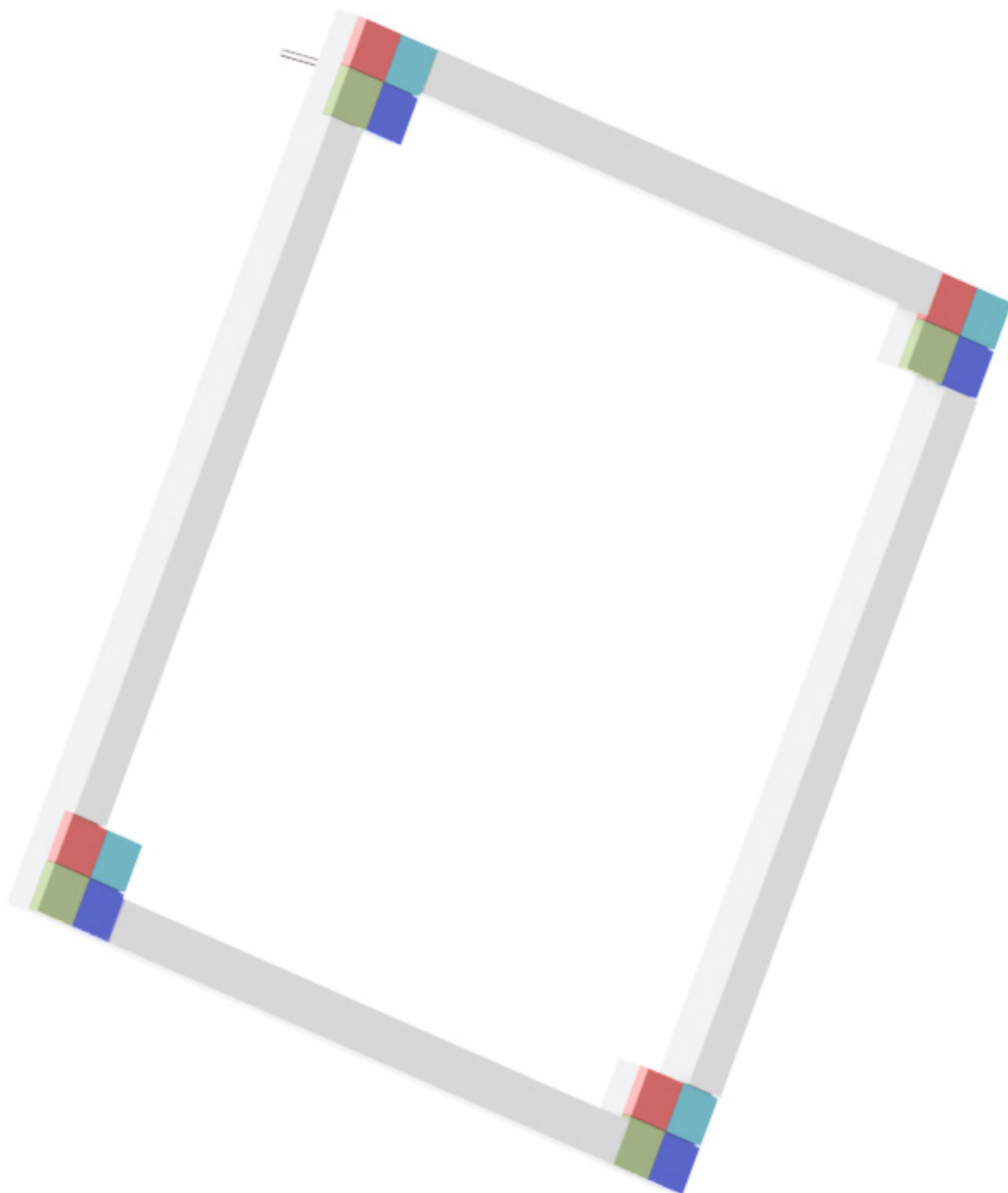

•• **Assembly Instructions** ••

Spare parts

3D printed parts

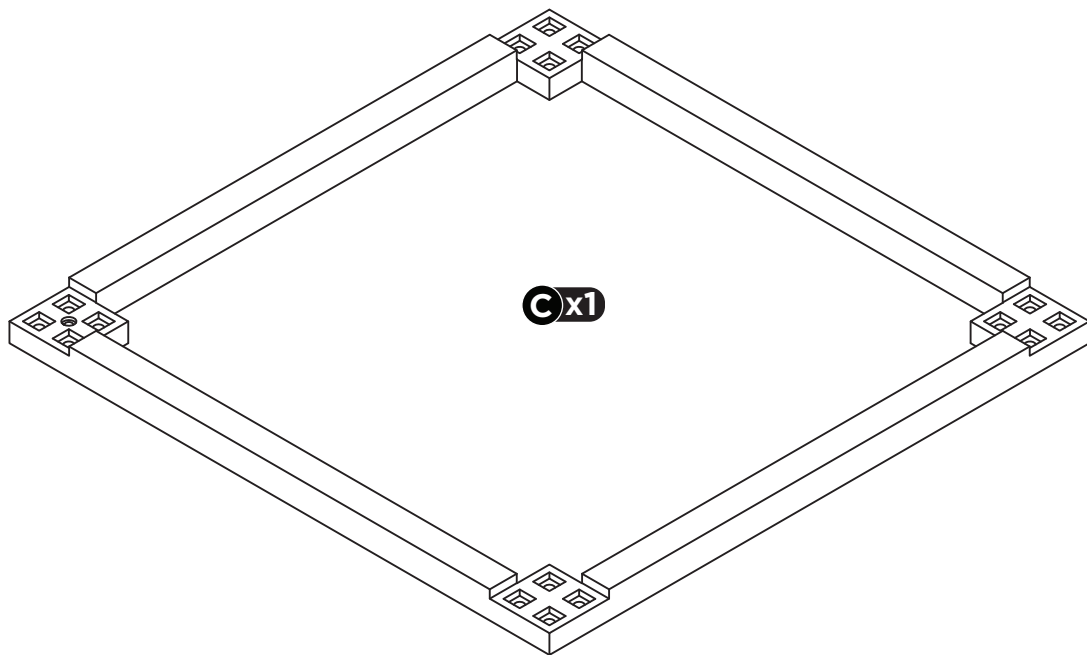

 **D x4**

 **E x4**

 **F x4**

 **G x4**

To buy in any DIY/Hardware shop

H x1 Stainless steel nail

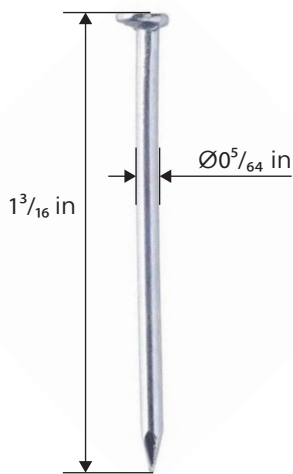

J x16 Zinc plated sheet metal screws



K x1 Screwdriver



Step 1

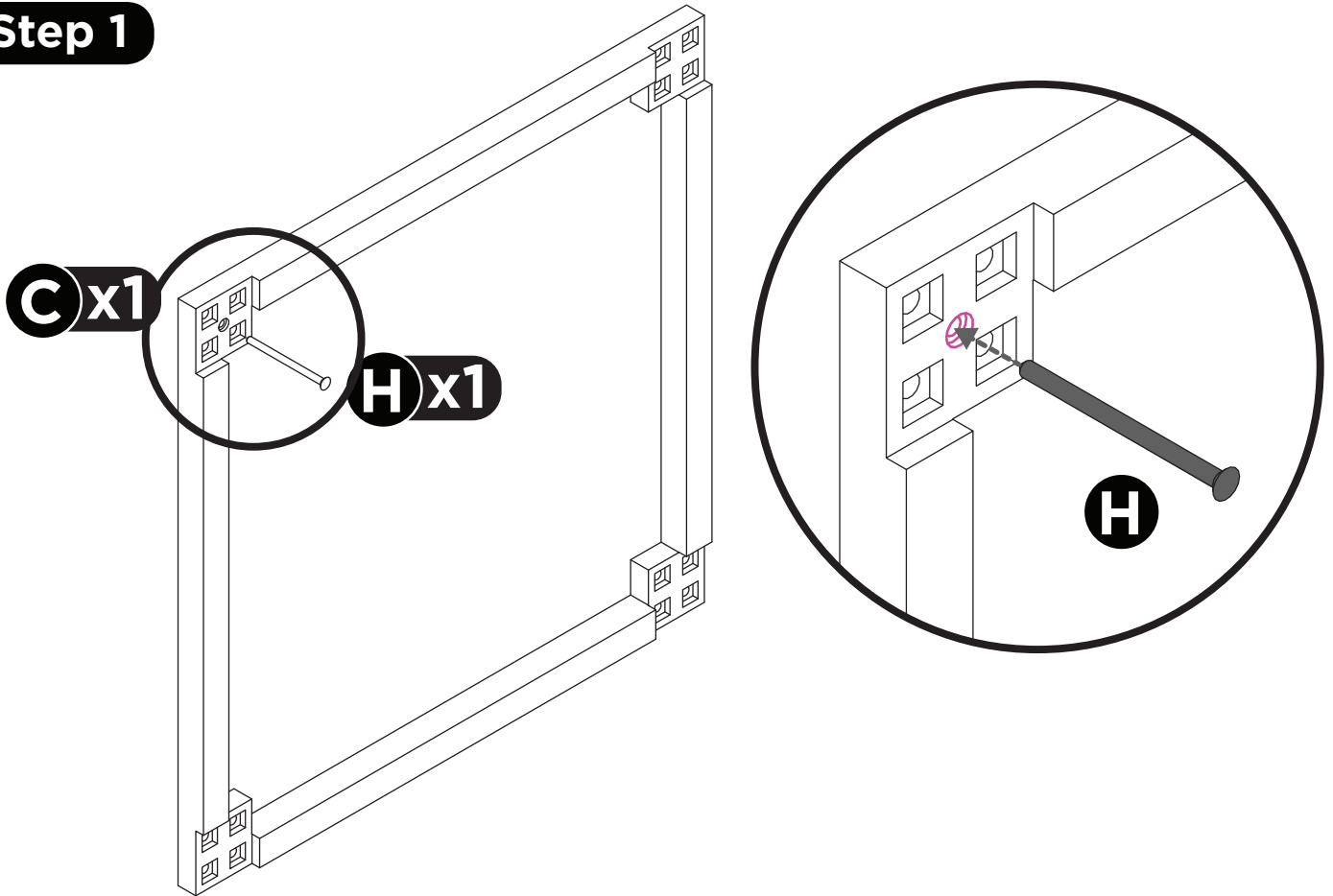

Step 2

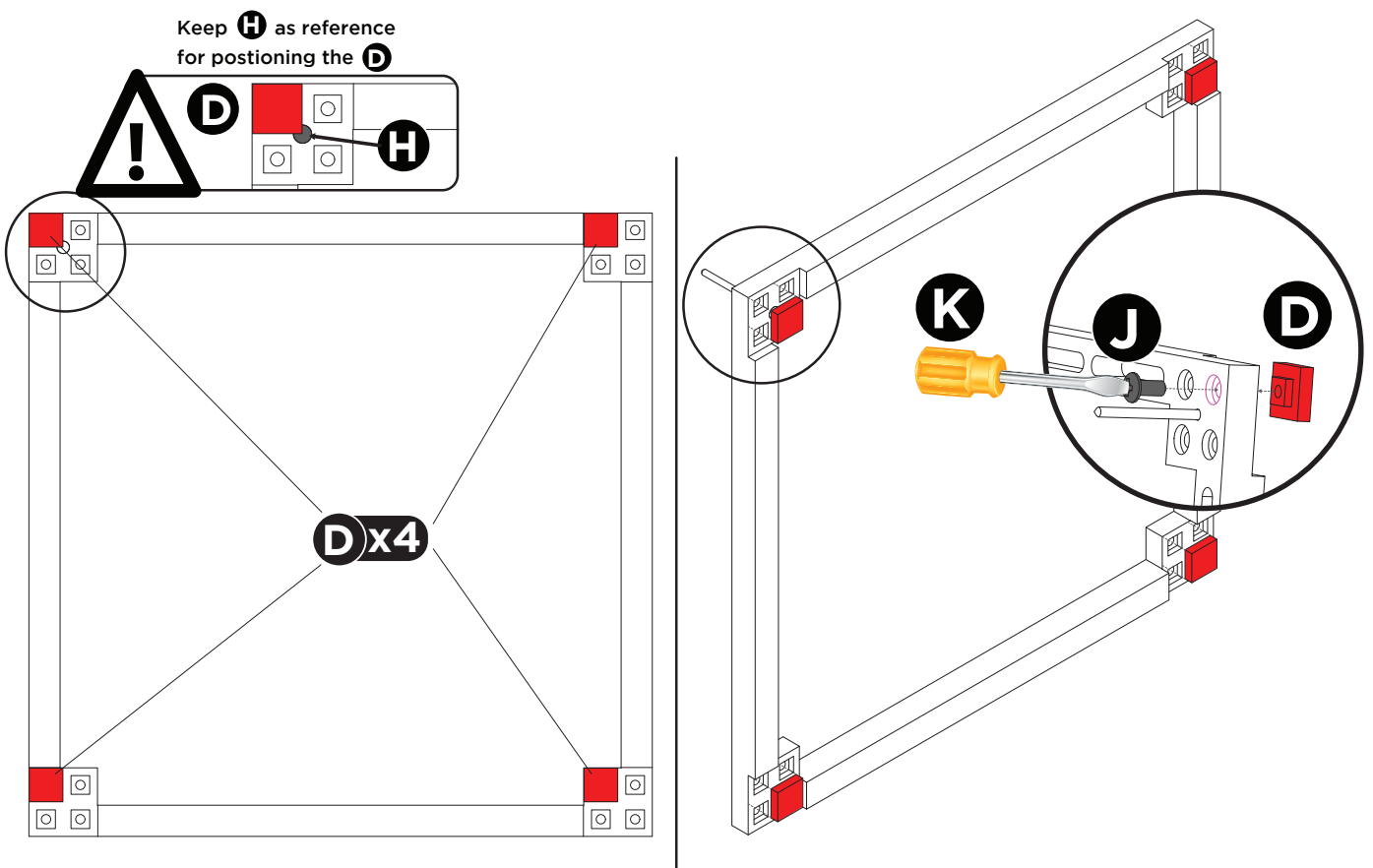

Step 3

Keep **D** as reference for positioning the **E**

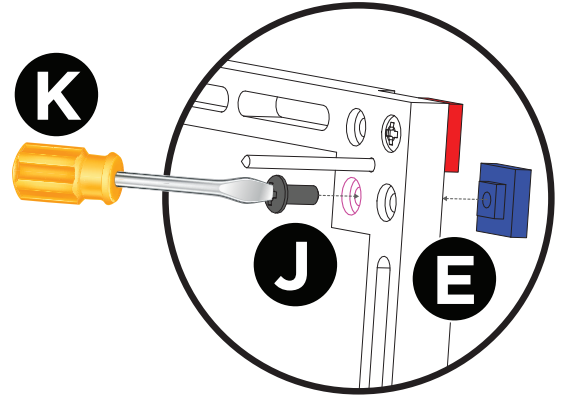
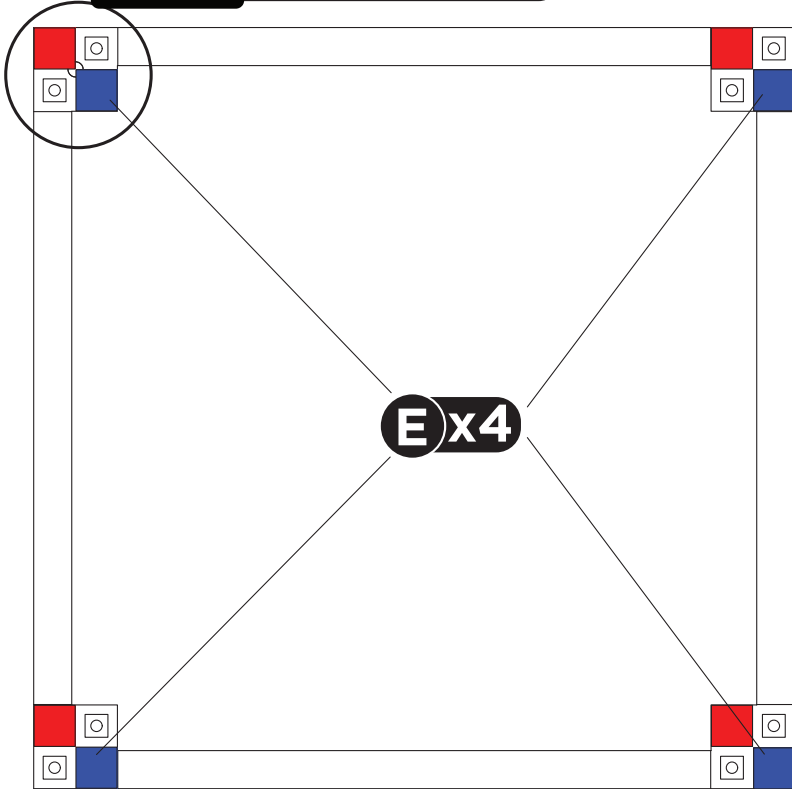
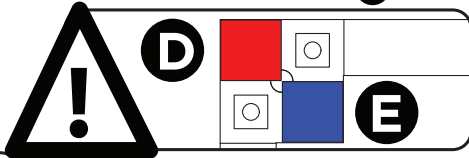

Step 4

Keep **E** as reference for positioning the **F**

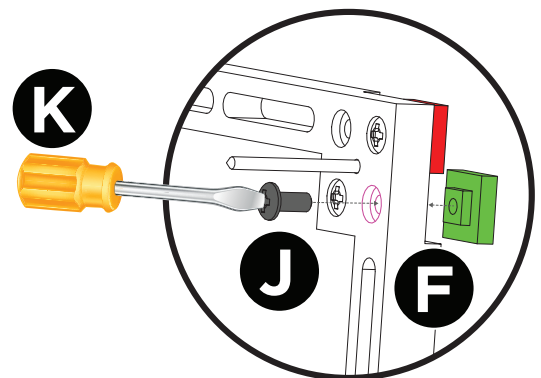
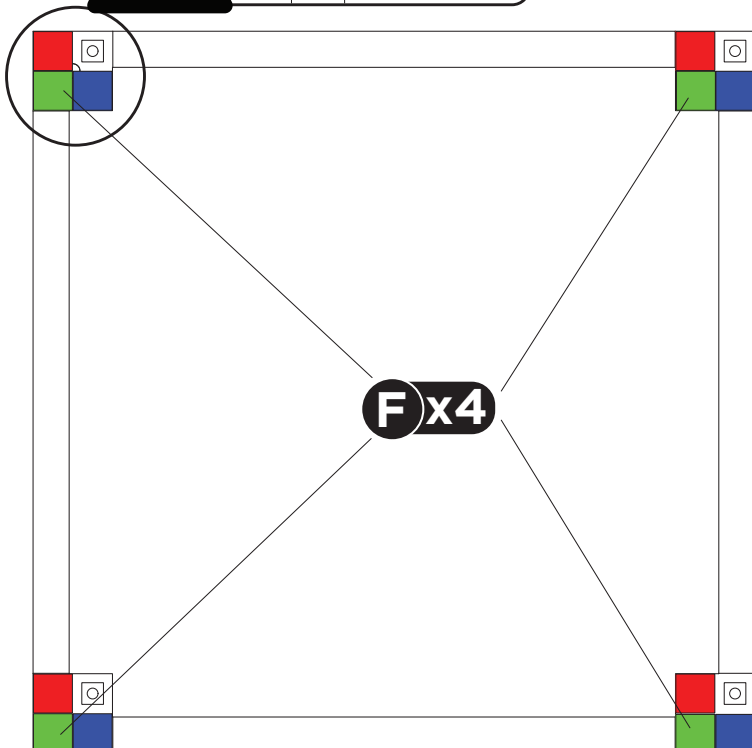

Step 5

Keep **F** as reference
for positioning the **G**

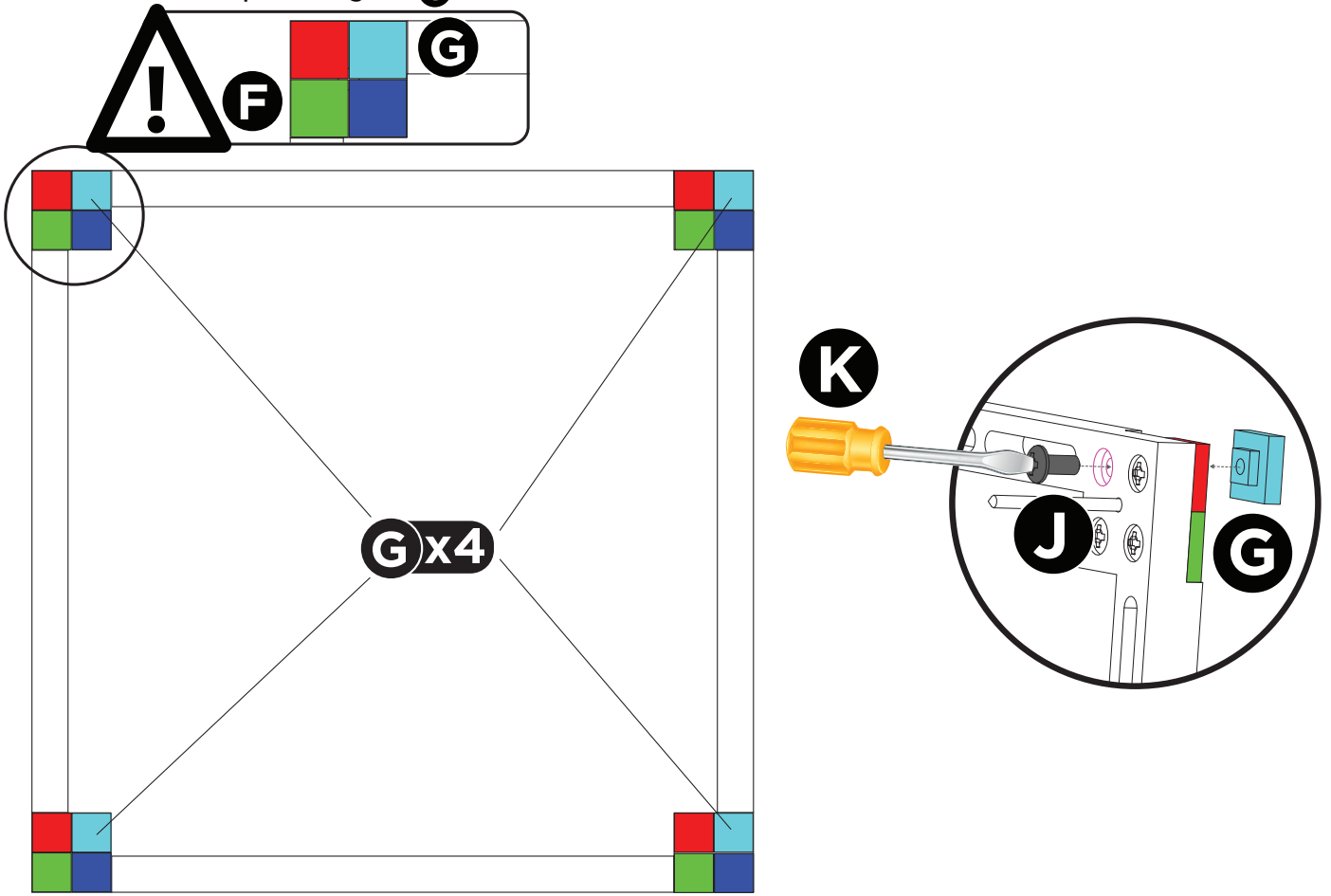

Step 6

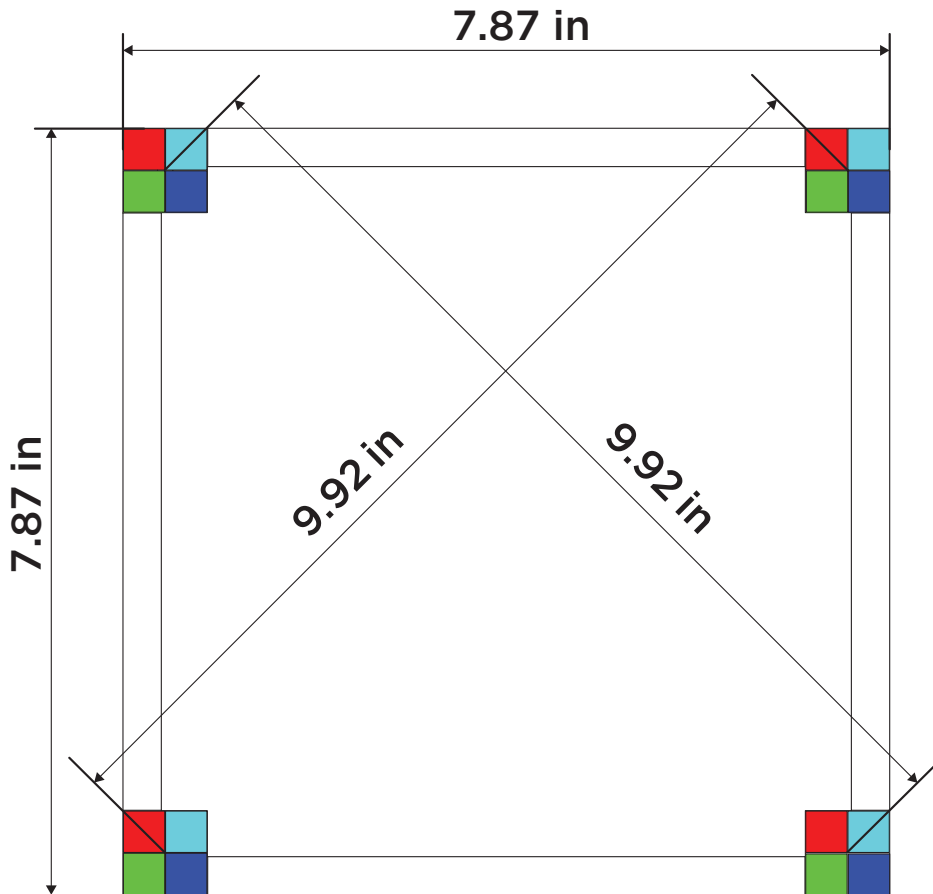

Final

Keep in mind: when placing the reference on the bundle, make sure that all the corners have the red color at the top.

